



PRODUCT CATALOGUE
BUCKET STEEL



Olofsfors wear steel - for maximum wear time

Olofsfors only uses Nordic raw materials for the boron alloy steels, which in an advanced manufacturing process are shaped and hardened to the highest quality. Through a long tradition and great professional skills in combination with our own research and development department, we always strive to be a market leader and offer the best possible products.

Satisfied customers in more than 40 countries use Olofsfors wear-resistant steel products daily.

In this catalogue you will find the Olofsfors Bruxite™ wear steel range as well as teeth and other products. Other products can be offered on request.

- + High quality Nordic steel
- + Hard and strong straight through
- + Maximum wear time
- + Large range of dimensions
- + Meets high tolerance requirements
- + Excellent welding properties
- + Systematic quality control

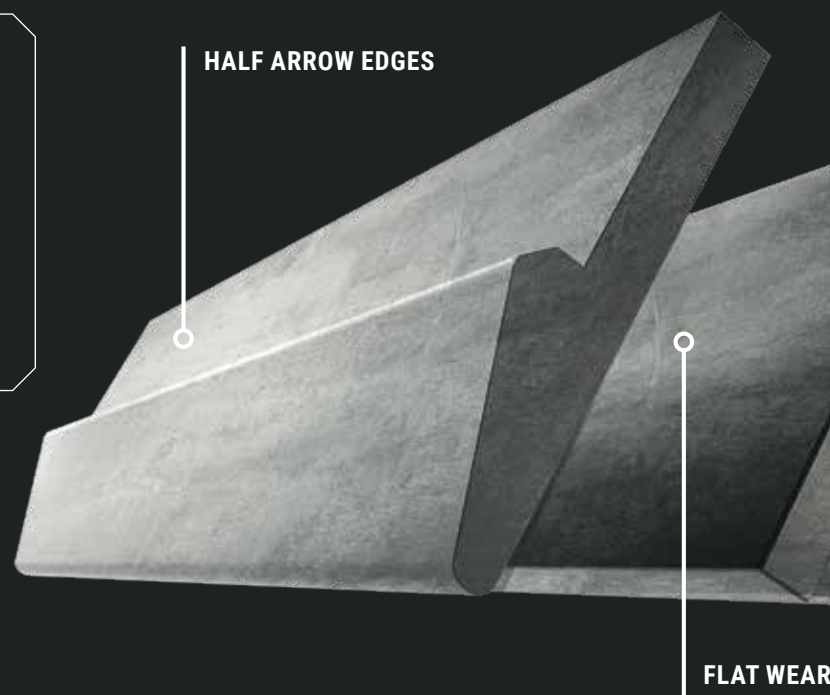

Table of contents

Cutting edges	4
Flat wear bars	5
Half arrow edges	6
Grouser bars and Round bars	7
Spade nose/delta-edges on demand	8
Wear plates	9
Bruxite™ BWB Bruxite™ Wear Blocks	10
Wear parts for crushers	11
Serrated grader blades	12
Flat grader blades	13
Base and Bolt-on edges Volvo type 1	14
Base and Bolt-on edges Volvo type 2 & 3	15
Spade nose and Bolt-on edges Volvo	18
Loader heel plate Volvo	18
Base and Bolt-on edges Cat	19
Spade nose and Bolt-on edges Cat	20
Base and Bolt-on edges Ljungby	21
Base and Bolt-on edges Universal	21
Base and Bolt-on edges snow plows	22
Base and Bolt-on edges snow plows Universal	23
Bolts and nuts	24
Bucket teeth type CAT J	25
Edge protectors	26
Excagrip™ Excavator spike	27
Welding instructions Bruxite™	28
Guidelines for welding	29
Tolerances	30

Contact

PHONE

+46 (0)930-311 40

E-MAIL

order@olofsfors.se

OPENING HOURS

Monday – Thursday 07.30–16.00

Friday 07.30–15.00

FOLLOW US ON SOCIAL MEDIA!



For more information, visit Olofsfors' website
www.olofsfors.com

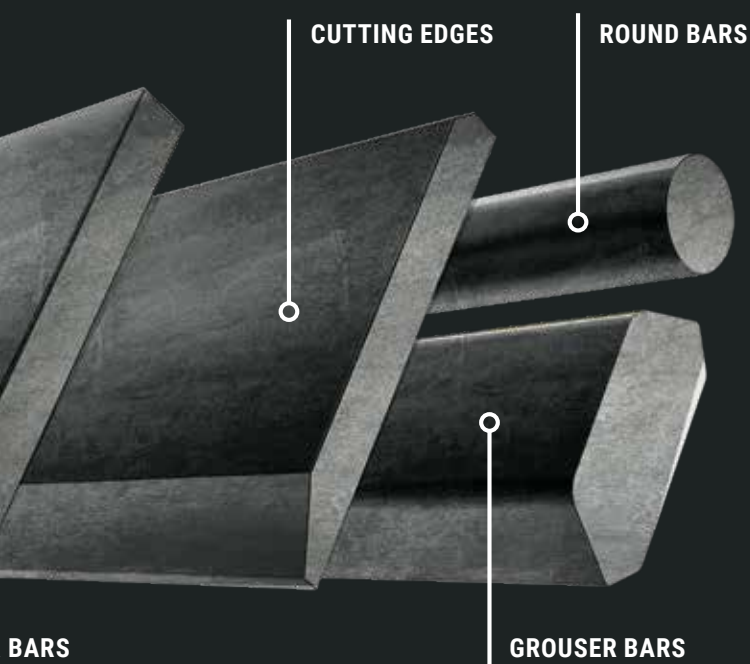

Bruxite™ Cutting edges



Bruxite™ cutting edges

Item No.	W. mm	T. mm	L. mm	Kg/pc
171-464570	100	12	3000	26,6
171-359340	100	12	6050	53,7
171-464750	100	16	3000	33,8
171-359350	100	16	6050	68,1
171-462040	150	16	2600	46,0
171-462670	150	16	3000	52,6
171-358680	150	16	6050	106,1
171-462050	150	20	2600	56,9
171-354810	150	20	3000	65,4
171-358690	150	20	6050	131,9
171-464640	200	20	1650	49,1
171-990773	200	20	2600	77,4
171-857423	200	20	3000	89,0
171-358700	200	20	6050	179,4
171-464660	200	25	1650	60,7
171-464670	200	25	2000	73,6
171-462060	200	25	2650	97,5
171-849681	200	25	3000	110,2
171-358710	200	25	6050	222,2
171-857424	200	30	3000	130,5
171-358730	200	30	6050	263,1
171-464680	250	25	1650	76,9
171-464690	250	25	2000	93,2
171-857425	250	25	3000	139,6
171-358720	250	25	6050	283,8
171-464700	250	30	1650	91,4
171-464710	250	30	1850	102,5
171-462690	250	30	3000	168,5
171-358740	250	30	6050	334,3

Item No.	W. mm	T. mm	L. mm	Kg/pc
171-466940	270	30	2000	120,3
171-461530	270	30	3000	179,9
171-857426	270	30	3500	210,5
171-358750	270	30	6050	362,8
171-460575	270	35	2070	143,7
171-460560	270	35	3000	208,2
171-462080	270	35	3650	250,8
171-358760	270	35	6050	419,9
171-477630	300	30	3000	201,1
171-491650	300	30	3650	245,3
171-360350	300	30	6050	409,0
171-362890	300	35	3000	233,0
171-360310	300	35	6050	473,7
171-465120	300	40	2050	179,3
171-012180	300	40	3000	262,2
171-461200	300	40	3650	319,3
171-358770	300	40	6050	533,1
171-462832	300	50	3650	392,6
171-360030	300	50	6050	650,8
171-468402	400	40	2070	247,6
171-468400	400	40	3650	433,9
171-468420	400	40	6000	719,2
1714-454962	400	50	6000	884,2
171-496110	400	60	2000	351,1
171-359010	500	50	1500	279,8
171-486520	500	50	6000	1 116,4
171-370550	500	60	2000	445,3
171-482610	700	60	2000	633,7
171-482940	750	70	2250	901,2

Bruxite™ Flat wear bars



Bruxite™ flat wear bars

Item No.	W. mm	T. mm	L. mm	Kg/pc
120-462790	61	10	3000	14,4
120-463980	80	10	3000	18,8
120-358790	80	10	6050	38,0
120-360640	80	16	3000	30,1
120-360620	80	16	6050	60,8
120-460574	80	20	1500	18,8
120-460571	80	20	2000	25,1
120-460440	80	20	3000	37,7
120-357160	80	20	6050	76,0
120-357170	80	25	6050	95,0
120-458800	100	10	3000	23,6
120-358800	100	10	6050	47,5
120-463540	100	12	3000	28,3
120-358820	100	12	6050	57,0
120-463310	100	16	3000	37,7
120-358860	100	16	6050	76,0
120-460170	100	20	3000	47,1
120-358890	100	20	6050	95,8
120-460540	100	25	3000	58,9
120-358920	100	25	6050	118,7
120-464820	100	30	3000	70,7
120-358950	100	30	6050	142,5
120-494820	100	40	6050	190,0

Item No.	W. mm	T. mm	L. mm	Kg/pc
120-490000	130	30	3000	91,9
120-467840	150	10	3000	35,3
120-462580	150	12	3000	42,4
120-358840	150	12	6050	86,2
120-458820	150	16	3000	56,5
120-358870	150	16	6050	114,0
120-462850	150	20	3000	71,8
120-358900	150	20	6050	142,5
120-461930	150	25	3000	88,3
120-358930	150	25	6050	178,1
120-486710	150	30	3000	106,0
120-486720	150	30	6050	213,7
120-458830	200	10	3000	47,1
120-458840	200	12	3000	56,5
120-462810	200	16	3000	75,4
120-458850	200	20	3000	94,2
120-358910	200	20	6050	190,0
120-458860	200	25	3000	117,8
120-458870	200	30	3000	141,3
120-360260	200	30	6050	285,0
120-467920	250	30	6050	353,3
120-358960	300	30	3000	212,0

Bruxite™ Half arrow edges

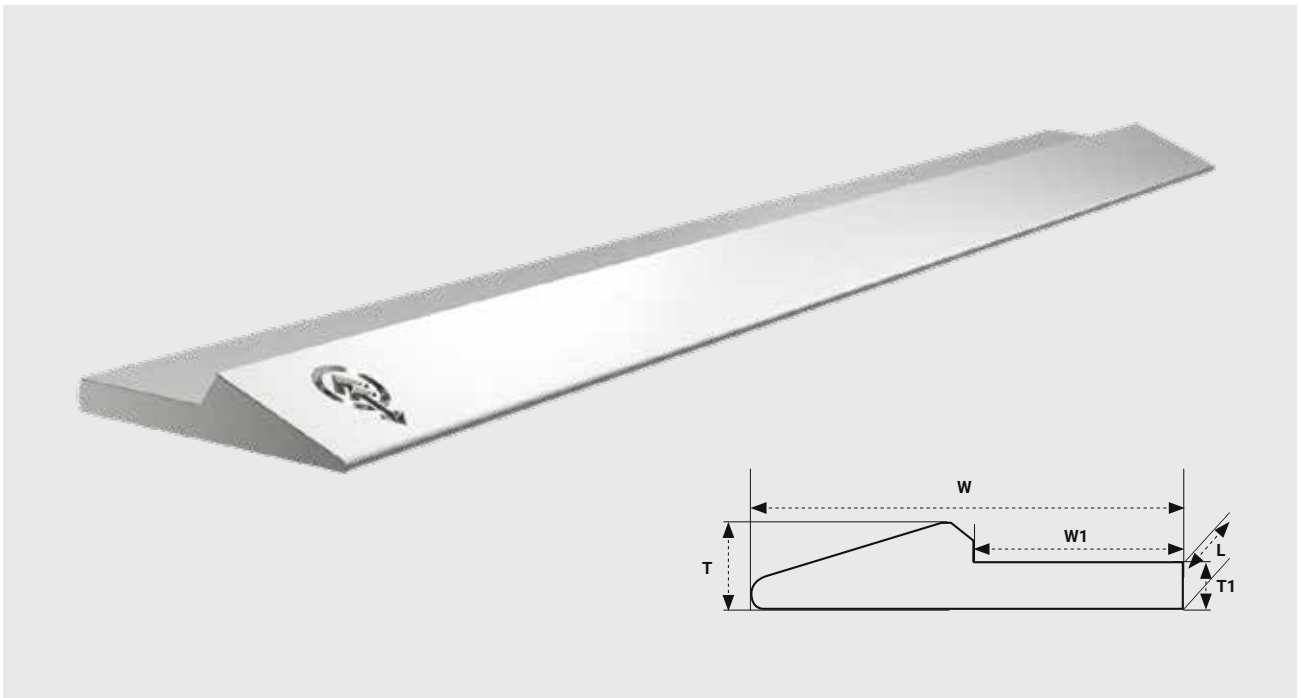

Bruxite™ half arrow edges

Item No.	W/W1. mm	T/T1. mm	L. mm	Kg/st
160-464830	101/46	21/11	3050	28,4
160-464832	101/46	21/11	6100	56,8
160-464840	151/68	32/16	3050	63,7
160-464842	151/68	32/16	6100	127,3
160-466910	203/127	32/19	3660	114,9
160-466920	254/130	57/29	3660	240,3
160-468650	254/130	68/40	3660	324,5

Bruxite™ Grouser bars

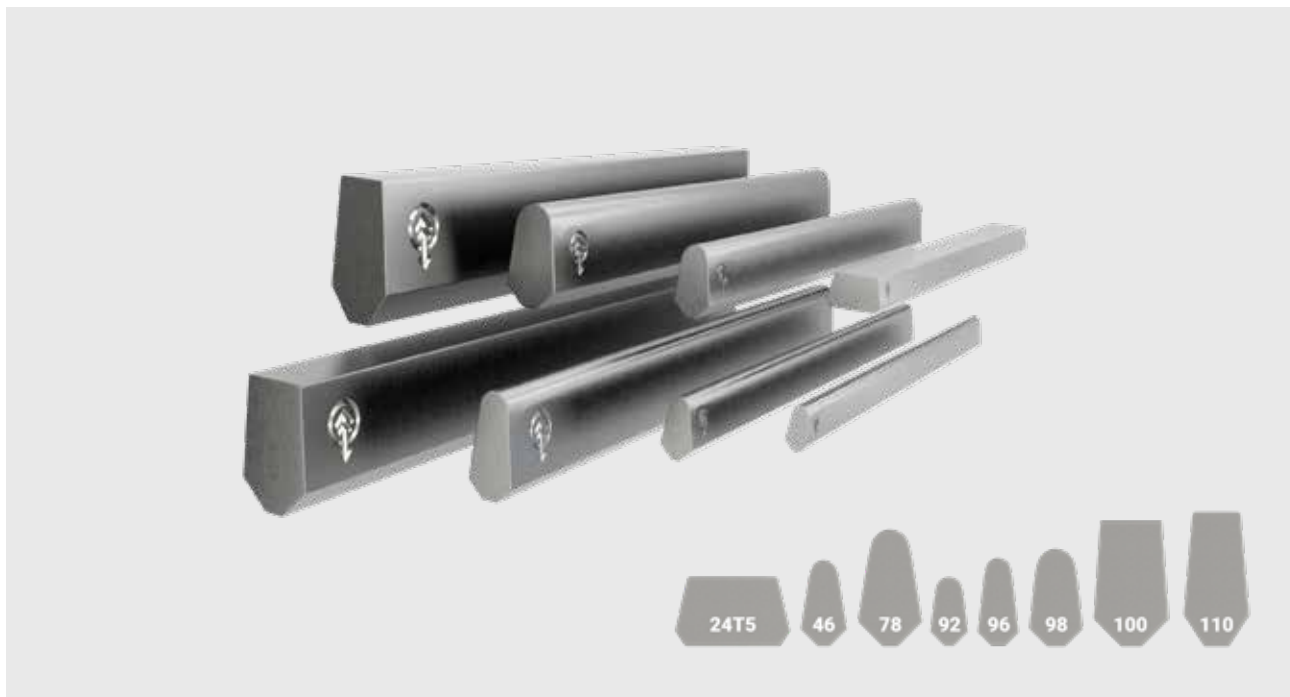

Bruxite™ grouser bars

Item No.	Note	Height mm	Width mm	Length mm	Weight kg
160-464930	Grouser bar 24-T5	24	42	3050	21,9
160-465370	Grouser bar 46	30	16	3000	9,6
160-456050	Grouser bar 78	40	22	3050	17,7
160-456030	Grouser bar 92	50	27	3050	25,7
160-464920	Grouser bar 96	65	30	3050	34,9
160-465740	Grouser bar 98	68	37	3050	46,9
160-490440	Grouser bar 100	75	45	3050	68,2
160-490460	Grouser bar 110	89	43,5	3010	75,1

Bruxite™ Round bars



Bruxite™ round bars

Item No.	ø mm	Length mm	Weight kg
120-470780	18	1500	3,0
802-480090	22	3000	9,0
120-481410	30	3000	16,6
120-492170	45	3000	37,4
802-476360	60	3000	66,6
120-492180	70	3000	90,6
120-477390	75	1150	36,7
120-477380	75	3000	104,0

Bruxite™ Spade nose/delta-edges on demand

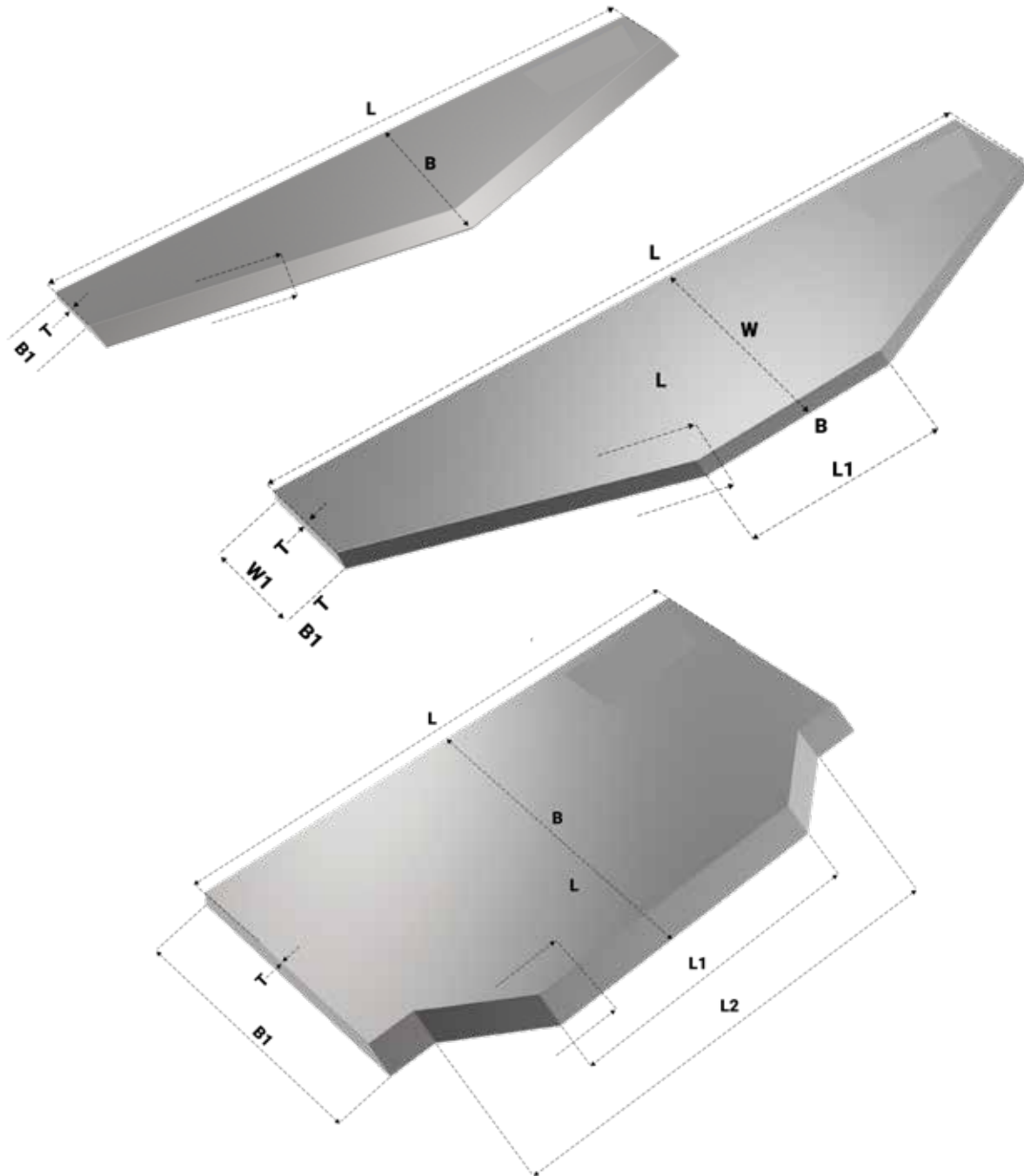

Bruxite™ spade nose/delta-edges

Spade nose / bolt-on edges, unholed or perforated are offered on request.

Enter measurements according to: $L/L1 \times B/B1 \times T$

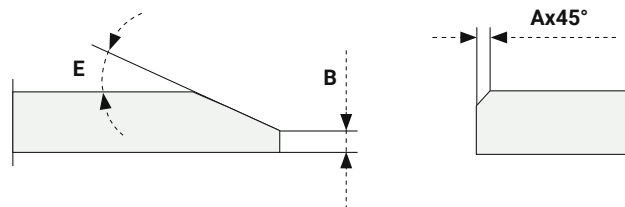

Bruxite™ Wear plates



Bruxite™ wear plates

Item No.	W. mm	T. mm	L. mm	OF	Kg/pc
130-900021	1000	8	3650		229,0
130-900031	1000	10	3650		287,0
130-900041	1000	12	3650		344,0
130-900051	1000	15	3650		430,0
130-900061	1000	20	3650		573,0
130-900071	1000	25	3650		716,0
130-900081	1000	30	3650		859,0
130-900090	1000	35	3650		1 003,0
130-900100	1000	40	3650		1 146,0

Bruxite™ BWB Bruxite™ Wear Blocks

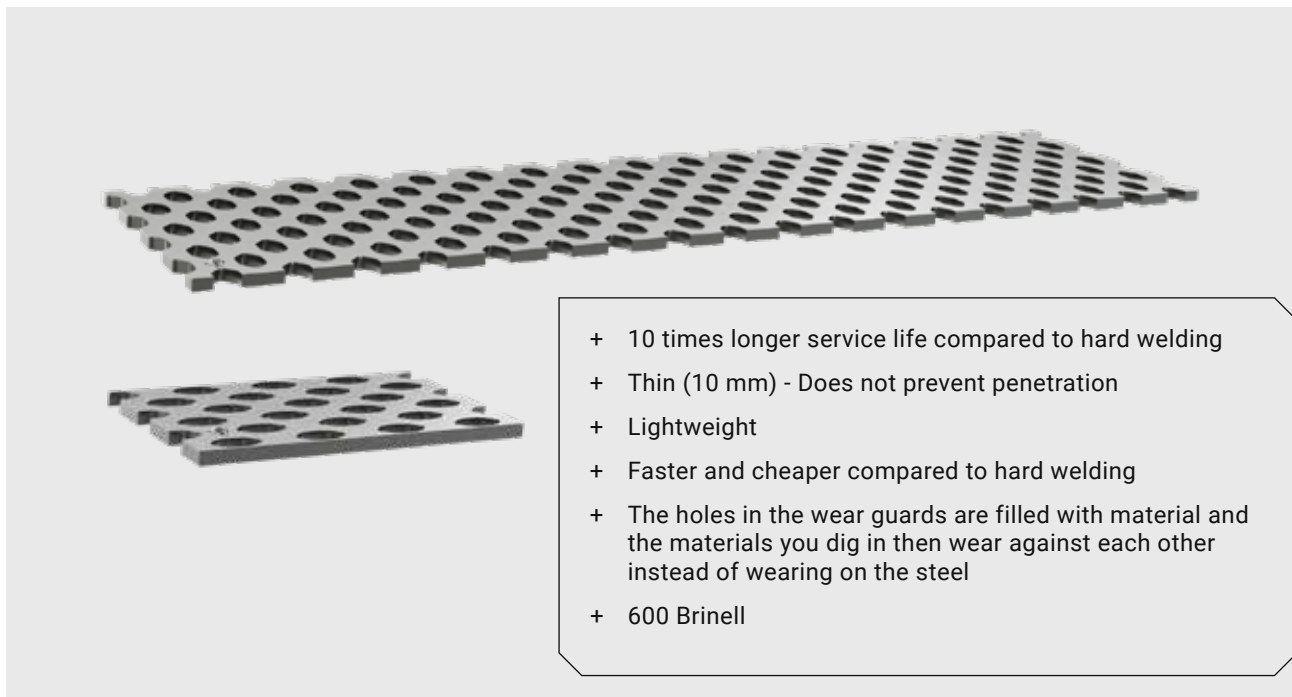

Bruxite™ BWB Bruxite™ Wear blocks

Item No.	W. mm	T. mm	L. mm	Kg/pc
122-455010	240	10	150	1,8
122-455020	240	10	915	11,1
122-455030	240	10	1220	14,7



Bruxite™ Wear parts for crushers

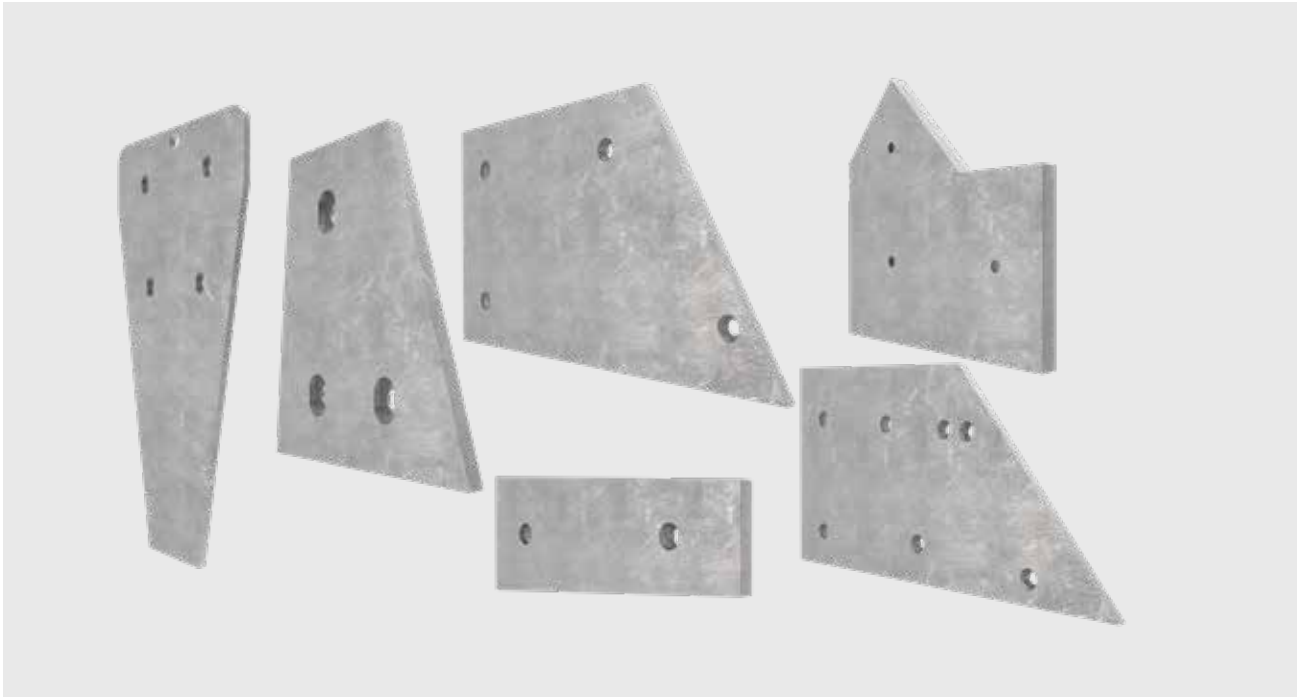

Olofsfors wear parts are manufactured in our unique Bruxite™ material.

Bruxite™ is a proven steel for meeting tough requirements in extreme environments. Olofsfors has supplied wear parts to a number of different crushing plants of well-known brands, including in Sweden, Asia and North America.

We have extensive experience and a large number of drawings and variants of wear parts that have been produced over the years.

In consultation with our customers, we can produce the wearing parts needed for each individual crushing plant.

Bruxite™ Serrated grader blades

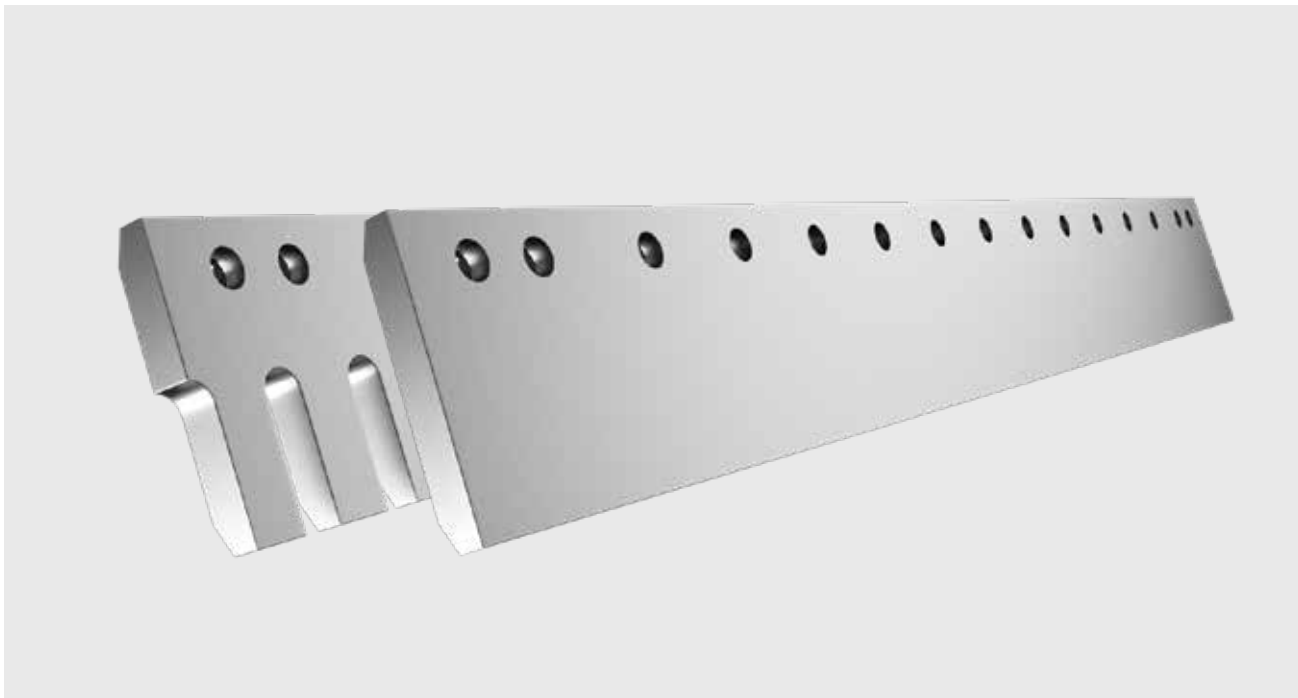

Bruxite™ serrated blades

Item No.	OEM No.	Bolt dim.	Holes	W. mm	T. mm	L. mm	Kg/pc
171-368775		M16	7	203	19	915	20,9
171-368776		M16	9	203	19	1220	27,9
171-368762	350-0179	M16	13	203	19	1828	44,0
171-368761	350-0181	M16	15	203	19	2133	51,3
171-368774		M20	7	203	19	915	20,7
171-368577		M20	9	203	19	1220	27,7
171-368760	350-0180	M20	15	203	19	2133	51,0
171-369010		M20	7	203	25	915	27,4
171-368763	7T3600	M20	9	203	25	1220	38,2
171-368764	7T3601	M20	11	203	25	1525	47,8
171-368767	4Z8055	M20	15	254	25	2133	79,4
171-368768	4Z8056	M20	17	254	25	2434	90,7
171-368769	4Z8346	M20	15	254	35	2133	110,0
171-368758	100-4581	M20	17	254	35	2434	124,9
171-368532	104-3631	M20	17	250	45	2434	161,9
171-368778		M20	9	330	35	1220	80,7
171-368758X		M20	17	330	35	2434	161,7
171-368531	134-1778	M20	17	330	45	2434	241,0
171-368533	138-6542	M24	9	330	45	1220	120,2
171-495505		M24	9	400	50	1220	185,0
171-368530	135-9796	M24	9	400	60	1213	171,0

Bruxite™ Flat grader blades

Bruxite™ flat blades

Item No.	OEM nr	Bolt dim.	Bolt hole	W. mm	T. mm	L. mm	Kg/pc
171-368700	4T2967	M16	11	200	16	1524	37,1
171-368701	4T2968	M16	13	200	16	1828	44,5
171-368702	4T2969	M16	15	200	16	2133	51,9
171-368703	4T2966	M16	17	200	16	2434	59,2
171-368704	4Z8119-6	M16	7	203	19	915	25,2
171-368705	4Z8129	M16	5	203	19	915	27,8
171-368706		M16	9	203	19	1220	33,8
171-368707	4Z8119	M16	6	203	19	1220	36,8
171-368708	4T3034	M16	11	203	19	1524	45,8
171-368709	4T3007	M16	13	203	19	1828	55,0
171-368710	4T3036	M16	15	203	19	2133	64,1
171-368711	4T3035	M16	17	203	19	2434	73,1
171-368712	135-9692	M16	9	203	25	1220	45,4
171-368713	7T3497	M16	11	203	25	1524	56,8
171-368714	7T3499	M16	13	203	25	1828	67,9
171-368715	7T3498	M16	15	203	25	2133	79,2
171-368716	7T3496	M16	17	203	25	2434	90,4
171-368720	4Z8120	M20	11	200	16	1524	36,9
171-368721	4T2971	M20	13	200	16	1828	44,2
171-368722	4T2970	M20	15	200	16	2133	51,6
171-368723	4T9603	M20	17	200	16	2434	58,9
171-369004		M20	7	203	19	915	25,1
171-369006		M20	9	203	19	1220	33,6
171-368718		M20	11	203	19	1525	42,8
171-368724	4T3033	M20	13	203	19	1828	54,6
171-368725	4T3032	M20	15	203	19	2133	63,7
171-368726	4T3037	M20	17	203	19	2434	72,7
171-368699		M20	7	203	25	915	33,5
171-368727	4Z8926	M20	9	203	25	1220	45,0
171-368728	7T3493	M20	13	203	25	1828	67,4
171-368729	7T3494	M20	15	203	25	2133	78,7
171-368730	7T3495	M20	17	203	25	2434	89,8
171-368731	4T6502	M20	13	254	25	1828	85,4
171-368732	4T6508	M20	15	254	25	2133	99,0
171-368733	4T6511	M20	17	254	25	2434	117,1
171-368734	4T8316	M20	15	254	35	2133	137,2
171-368520	4T8317	M20	17	254	35	2434	159,9
171-368735	104-3628	M20	17	250	45	2434	199,5
171-368736	140-6790	M20	15	280	25	2133	111,5
171-368737	4Z9186	M20	17	280	25	2434	127,3
171-368738	132-1086	M20	17	280	35	2434	177,7
171-368739	4Z9188	M20	17	300	35	2434	191,1
171-368741	128-2577	M20	17	330	45	2434	268,4
171-368750	109-3117	M24	9	330	30	1220	90,1
171-368751	109-3116	M24	9	330	45	1220	133,2
171-368752	132-1019	M24	9	330	60	2438	350,6
171-368753	135-9690	M24	9	400	30	1220	110,2
171-368754	138-6440	M24	9	400	45	1220	163,4
171-495500		M24	9	400	50	1220	184,3
171-368755	135-9349	M24	9	400	60	1220	220,0

Base and Bolt-on edges VOLVO

Base and Bolt-on edges VOLVO type 1



Item No.	Name	Quantity	Dimension mm	Kg/pc	Reference no.	Note	Stock	Bolt/no.
171-857501	Base edge		150x20x2130	46	4857501		○	M16x55
171-857492	Bolt-on edge	3	220x16x710	18	4857492		●	9 pc
171-155450	Bolt-on edge serrated	3	220x16x710	15	4857492		○	9 pc
171-010634	Base edge		150x20x2240	49	11010634		○	M16x55
171-010633	Bolt-on edge	3	220x16x744	21	11010633		○	9 pc
171-857502	Base edge		200x20x2300	69			○	M16x55
171-857493	Bolt-on edge	3	220x16x768	20			●	9 pc
171-156030	Bolt-on edge serrated	3	220x16x768	15	4857493		○	9 pc
171-857503	Base edge		200x25x2430	91	4857503		○	M20x60
171-857494	Bolt-on edge	4	254x19x608	23	4857494		●	12 pc
171-154510	Bolt-on edge serrated	4	254x19x608	16			●	12 pc
171-859527	Base edge		200x25x2500	91	4859527		○	M20x60
171-857495	Bolt-on edge	4	300x20x626	29	4857495		●	12 pc
171-010184	Base edge		200x30x2750	118	11010184		●	M24x70
171-857496X	Bolt-on edge	4	330x25x686	42	"4857496"		●	12 pc
171-156020	Bolt-on edge serrated	4	330x25x686	31	4857496SE		●	12 pc
171-010185	Base edge		270x35x2950	204	11010185		○	M24x80
171-010187X	Bolt-on edge	4	330x25x732	44	"11010187"		○	12 pc
171-859041	Base edge		200x25x3000	115	4859041		●	M24x65
171-354110	Base edge		200x30x3000	129	"859041"		●	M24x70
171-859042	Bolt-on edge	5	250x25x608	28	4859042		●	15 pc
171-859042X	Bolt-on edge	5	330x25x608	37	"4859042"		●	15 pc
171-466721	Bolt-on edge serrated	5	330x25x608	31	4859042SE		●	15 pc
171-857506	Base edge		300x40x3200	281	4857506		○	M24x80
171-857497X	Bolt-on edge	4	360x30x800	60	"4857497"		●	12 pc
171-858008	Base edge		200x25x3500	127	4858008		○	M24x65
171-857496X	Bolt-on edge	5	330x25x686	42	"4857496"		●	15 pc
171-156020	Bolt-on edge	5	330x25x686	31	4857496SE		●	15 pc
171-345301	Base edge		270x35x4000	269	"4858009"	Countersunk	○	M24x65
171-857497X	Bolt-on edge	5	360x30x800	60	"4857497"		●	15 pc

Base and Bolt-on edges VOLVO



Base and Bolt-on edges VOLVO type 2 & 3

Item No.	Name	Quantity	Dimension mm	Kg/pc	Reference no.	Note	Stock	Bolt/no
171-010393	Base edge		200x20x2300	67	11010393		○	M16x55
171-011143	Bolt-on edge	1	254x19x1248	45	"11011143"	Kit 80133	○	
171-011414	Bolt-on edge	2	254x19x521	19	"11011414"		●	17 pc
171-012935	Base edge		200x20x2380	70	11012935		○	M16x55
171-012938	Bolt-on edge	1	254x19x1328	51	"11012938"		○	
171-011414	Bolt-on edge	2	254x19x521	19	"11011414"		●	17 pc
171-081543	Base edge		200x20x2500	74	11081543		○	M16x55
171-081544	Bolt-on edge	1	254x19x1448	53	"11081544"		●	
171-011414	Bolt-on edge	2	254x19x521	19	"11011414"		●	18 pc
171-011438	Base edge		200x25x2500	91	11011438		○	M16x65
171-012887	Bolt-on edge	1	280x20x1448	59	11012887	Kit 80134	●	
171-011413	Bolt-on edge	2	367x20x521	28	11011413		●	21 pc
171-156508	Base edge		200x25x2550	92	11156508		○	M16x65
171-156585	Bolt-on edge	1	280x20x1472	61	11156585		○	
171-156579	Bolt-on edge	2	367x20x534	29	11156579		●	20 pc
171-012803	Base edge		200x20x2650	78	11012803		○	M16x55
171-012832	Bolt-on edge	1	280x20x1598	66	11012832		●	
171-011413	Bolt-on edge	2	367x20x521	28	11011413		●	22 pc
171-010395	Base edge		200x30x2650	113	11010395		●	M20x65
171-011111	Bolt-on edge	1	300x25x1348	74	11011111		●	
171-011112	Bolt-on edge	2	387x25x646	46	11011112		●	21 pc
171-045661	Base edge		250x30x2650	144	11045661		○	M20x65
171-045948	Bolt-on edge	1	300x25x1494	82	11045948	Kit 93417	●	
171-045947	Bolt-on edge	2	387x25x574	41	11045947		●	20 pc
171-045948X	Bolt-on edge	1	330x25x1494	90	"11045948"		○	
171-045947X	Bolt-on edge	2	330x25x574	35	"11045947"		○	20 pc
171-045949	Segment	7	300x30x245	16	11045949	Kit 93423	○	14 pc
171-081049	Base edge		200x25x2750	100	11081049		●	M20x60
171-082218	Base edge		250x30x2750	151	11082218		○	M20x65
171-081051	Bolt-on edge	1	300x25x1448	85	11081051		●	
171-011112	Bolt-on edge	2	387x25x646	46	11011112		●	21 pc
171-156728	Base edge		250x30x2750	150	11156728		○	M20x65
171-156729	Bolt-on edge	1	300x25x1608	115	11156729		○	
171-156731	Bolt-on edge	2	387x25x566	40	11156731		○	20 pc
171-156729X	Bolt-on edge	1	360x30x1608	128	"11156729"		○	
171-156731X	Bolt-on edge	2	360x30x566	45	"156731"		○	16 pc
171-010396	Base edge		270x35x2850	196	11010396		●	M20x70
171-358540	Base edge		270x35x2850	192	"11010396"	Countersunk	○	M20x60
171-011153	Bolt-on edge	1	350x25x1600	103	11011153		●	
171-011154	Bolt-on edge	2	461x25x622	53	11011154		●	21 pc
171-011153X	Bolt-on edge	1	360x30x1600	120	"11011153"		○	
171-011154X	Bolt-on edge	2	360x30x622	47	"11011154"		○	15 pc
171-045768	Base edge		270x35x2880	197	11045768		○	M20x70
171-156275	Base edge		270x35x2880	196	"11156275"	Countersunk	○	M20x60
171-045809	Bolt-on edge	1	350x25x1624	105	11045809	Kit 93418	●	
171-045808	Bolt-on edge	2	461x25x624	53	11045808		●	25 pc
171-045809X	Bolt-on edge	1	360x30x1624	121	"11045809"		●	
171-045808X	Bolt-on edge	2	360x30x624	47	"11045808"		●	21 pc
171-045810X	Segment	7	360x30x280	22	"11045810"	Kit 93424	○	21 pc
171-081024	Base edge		200x25x3000	109	11081024		○	M20x60
171-012955	Bolt-on edge	1	300x25x1698	93	11012955		●	
171-011112	Bolt-on edge	2	387x25x646	46	11011112		●	22 pc

Base and Bolt-on edges VOLVO

Base and Bolt-on edges VOLVO type 2 & 3

Item No.	Name	Quantity	Dimension mm	Kg/pc	Reference no.	Note	Stock	Bolt/no.
171-156764	Base edge		270x35x3000	206	11156764		○	M20x70
171-156766	Bolt-on edge	1	350x25x1682	109	11156766		●	
171-156765	Bolt-on edge	2	461x25x655	56	11156765		●	20 pc
171-156766X	Bolt-on edge	1	360x30x1682	126	"11156766"		○	
171-156765X	Bolt-on edge	2	360x30x655	49	"11156765"		○	16 pc
171-082219	Base edge		270x35x3000	207	11082219		○	M20x70
171-082219X	Base edge		270x30x3000	175	"110082219"	Countersunk	○	M20x60
171-082755	Bolt-on edge	1	350x25x1745	113	11082755		●	
171-011154	Bolt-on edge	2	461x25x622	53	11011154		●	21 pc
171-111884	Base edge		300x40x3000	260	11111884		○	M24x80
171-111886	Bolt-on edge	1	380x30x1682	141	11111886	Kit 93746	●	
171-111885	Bolt-on edge	2	480x30x655	69	11111885		●	20 pc
171-111054	Segment	7	380x35x270	26	11111054	Kit 93425	○	14 pc
171-081059	Base edge		200x30x3200	137	11081059		●	M24x70
171-081068	Bolt-on edge	1	380x30x1467	123	11081068		●	
171-468570	Bolt-on edge	2	380x30x863	72	"11081069"		●	21 pc
171-081068X	Bolt-on edge	2	406x35x1467	155	"11081068"		●	
171-081069X	Bolt-on edge	1	406x35x863	91	"11081069"		○	21 pc
171-467900	Base edge		300x40x3200	278	11156282	Countersunk	●	M24x65
171-082599	Base edge		300x40x3200	278	11082599	Not for segment	○	M24x80
171-082666	Bolt-on edge	1	380x30x1818	153	11082666	Kit 94751	●	
171-082664	Bolt-on edge	2	480x30x687	73	11082664		●	20 pc
171-082666X	Bolt-on edge	1	406x35x1818	192	11082666		●	
171-082664X	Bolt-on edge	2	406x35x687	72	11082664		●	20 pc
171-370200	Bolt-on edge	1	380x38x1818	191	11082666		●	
171-370190	Bolt-on edge	2	480x38x687	91	11082664		●	20 pc
171-482660	Bolt-on edge	1	270x35x1818	125	11082666	Not reversibile	●	
171-482670	Bolt-on edge	2	270x35x687	47	11082666	Not reversibile	●	16 pc
171-453920	Bolt-on delta edge	1	700/500x40x3230	580		Tip	○	30 pc
171-111055	Segment	7	380x35x280	27	11111055		○	14 pc
171-111887	Segment	7	380x35x300	29	11111887	Kit 93427	●	14 pc
171-011630	Base edge		200x25x3400	123	11011630		○	M20x60
171-011631	Bolt-on edge	1	300x25x2098	115	11011631		●	
171-011112	Bolt-on edge	2	387x25x646	46	11011112		●	25 pc
171-081063	Base edge		200x30x3400	146	11081063		○	M24x70
171-081065	Bolt-on edge	1	380x30x1666	140	11081065		●	
171-468570	Bolt-on edge	2	380x30x863	72	"11081069"		●	19 pc
171-142595	Base edge		300x40x3400	287	11142595	Countersunk	●	M24x65
171-111776	Bolt-on edge	1	380x30x1954	164	11111776	Kit 93666	●	
171-111775	Bolt-on edge	2	480x30x719	76	11111775		●	23 pc
171-479800	Bolt-on edge	1	406x41x1954	238	"11111776"		●	
171-479790	Bolt-on edge	2	500x40x719	125	"11111775"		●	23 pc
171-111776X	Bolt-on edge	1	406x35x1954	206	"11111776"	Kit 80115	●	
171-111775X	Bolt-on edge	2	406x35x719	75	"11111775"		●	23 pc
171-482690	Bolt-on edge	1	270x35x1954	134	"11111776"	Not reversibile	●	
171-482680	Bolt-on edge	2	270x35x719	49	"11111775"	Not reversibile	●	19 pc
171-453901	Bolt-on spade nose edge	1	700/350x40x3430/300	549		Trubb	○	37 pc
171-453902	Bolt-on delta edge	1	500/700x40x3430	614		Tip	○	37 pc
171-142594	Base edge		300x40x3430	298	11142594	Countersunk	○	M24x65
171-111761X	Segment	7	406x35x340	35	"11111761"	Kit 93667	●	21 pc

Base and Bolt-on edges VOLVO

Base and Bolt-on edges VOLVO type 2 & 3

Item No.	Name	Quantity	Dimension mm	Kg/pc	Reference no.	Note	Stock	Bolt/no.
171-155370	Base edge		300x40x3580	303	15155370	Countersunk	●	24Mx65
171-155526	Bolt-on edge	1	380x30x2074	175	15155526		●	
171-155527	Bolt-on edge	2	480x40x748	79	15155527		●	23 pc
171-370420	Bolt-on edge	1	380x38x2074	218	"15155526"		●	
171-370430	Bolt-on edge	2	480x38x748	99	"1515527"		●	23 pc
171-453925	Bolt-on delta edge	1	700/500x40x3610	651		Tip	○	23 pc
171-155370	Base edge		300x40x3580	303	15155370	Countersunk	●	24Mx65
171-155526	Bolt-on edge	1	380x30x2074	175	15155526		●	
171-155527	Bolt-on edge	2	480x30x748	79	15155527		●	23 pc
171-370420	Bolt-on edge	1	380x38x2074	218	"15155526"		●	
171-370430	Bolt-on edge	2	480x38x748	99	"15155527"		●	23 pc
171-453925	Bolt-on delta edge	1	700/500x40x3610	651		Tip	○	23 pc
171-460800	Base edge		300x40x3650	312	17460800	Countersunk	●	M24x65
171-370170	Bolt-on edge	1	380x38x1965	206	"11081066"	Kit 86913	●	
171-370310	Bolt-on edge	2	480x38x838	111	"17480177"		●	24 pc
171-081058	Base edge		200x30x3700	159	11081058		○	M24x70
171-081066	Bolt-on edge	1	380x30x1965	165	11081066		●	
171-468570	Bolt-on edge	2	380x30x863	72	"11081069"		●	20 pc
171-491250	Base edge		300x40x3700	304	11111691	Countersunk	○	M24x65
171-081066	Bolt-on edge	1	380x30x1965	165	11081066		●	
171-081069	Bolt-on edge	2	480x30x863	91	11081069		●	24 pc
171-370170	Bolt-on edge	1	380x38x1965	206	"11081066"		●	
171-370160	Bolt-on edge	2	480x38x863	112	"11081069"		●	24 pc
171-082431	Base edge		370x65x3970	647	11082431	Countersunk	○	1 1/4"x3-3/4 (95)
171-082433	Bolt-on edge	1	430x40x1422	179	11082433		●	
171-082434	Bolt-on edge	2	430x40x1265	159	11082434	Kit 94458	●	19 pc
171-111134	Segment	7	430x50x340	48	11111134	Kit 93665	○	21 pc
930-466625	Bolted shroud	7	372x113/50x340	44	15206	CWP	○	21 pc

Spade nose and Bolt-on edges VOLVO



Item No.	Name	Quantity	Dimension mm	Kg/pc	Reference no.	Note	Stock	Bolt/no.
171-156280	Spade nose edge		3230/850x590/272x40	453	11156280	Countersunk	○	M24x65
171-111889X	Bolt-on edge CTR	1	406x35x1010	107	"11111889"		●	
171-045618X	Bolt-on edge LH	1	406x35x1246	120	"11045618"		●	
171-045619X	Bolt-on edge RH	1	406x35x1246	120	"11045619"		●	16 pc
171-111054	Segment	7	380x35x270	26	11111054		○	14 pc
171-111055	Segment	7	380x35x280	27	11111055		○	14 pc
171-142596	Spade nose edge		3430/850x620/272x40	496	11142596	Countersunk	●	M24x65
171-111762	Bolt-on edge CTR	1	500x30x1094	120	11111762	Kit 93422	●	
171-111011	Bolt-on edge LH	1	380x30x1308	100	11111011		●	
171-111012	Bolt-on edge RH	1	380x30x1308	100	11111012		●	23 pc
171-372350	Bolt-on edge CTR	1	500x40x1094	160	"11111762"	Kit 93422	●	
171-372370	Bolt-on edge LH	1	406x41x1308	148	"11111011"		●	
171-372360	Bolt-on edge RH	1	406x41x1308	148	"11111012"		●	23 pc
171-159120	Spade nose edge		3580/894x650/290x50	674	15159120	Countersunk	○	M24x80
171-372320	Bolt-on edge CTR	1	500x40x1135	156	"15159420"		●	
171-372340	Bolt-on edge LH	1	406x41x1265	156	"15159421"		●	
171-372330	Bolt-on edge RH	1	406x41x1266	156	"15159422"		●	23 pc
171-111761X	Segment	7	406x35x330	34	"11111761"		●	21 pc
171-183830	Segment	7	380x45x290	34	11183830		○	21 pc
171-360260	Spade nose edge		3750/850x620/272x40	538		Countersunk	○	M24x65
171-372350	Bolt-on edge CTR	1	500x40x1094	160	"11111762"		●	
171-372390	Bolt-on edge LH	1	406x41x1368	169			○	
171-372380	Bolt-on edge RH	1	406x41x1368	169			○	25 st
171-360265	Spade nose edge		3800/1220x620-272x40	566		Countersunk	○	M24x65
171-370410	Bolt-on edge CTR	1	500x40x1464	213			○	
171-372370	Bolt-on edge LH	1	406x41x1308	148	"11111011"		●	
171-372360	Bolt-on edge RH	1	406x41x1308	148	"11111012"		●	23 pc
171-111126	Spade nose edge		3970/692x790/352x65	1138	11111126	Countersunk	○	1 1/4"x3-3/4 (95)
171-489050	Spade nose edge		3970/692x790/352x50	897	"11111126"	Countersunk	○	1 1/4"x3-3/4 (95)
171-111135	Bolt-on edge CTR	1	600x40x1239	204	11111135	Kit 93664	●	
171-111136	Bolt-on edge LH	1	430x40x1524	172	11111136		●	
171-111137	Bolt-on edge RH	1	430x40x1524	172	11111137		●	23 pc
171-111134	Segment	7	430x50x340	48	11111134	Kit 93665	○	21 pc
930-466625	Bolted shroud	7	372x113/50x340	44	15206	CWP	○	21 pc

Bruxite™ Loader heel plate VOLVO



Item No.	Quantity	Dimension mm	Weight kg/pc	Reference no.	Note	Stock	Bolt	No.
171-142174	2	280x20x400	16	11142174	L50/L60/L70	○	M16x50	8
171-142033	2	300x20x 550	22	11142033	L90/L110/L120	●	M20x60	8
171-111811	2	350x25x 600	38	11111811	L150/L180	●	M24x65	8
171-111282	2	400x35x 570	56	11111282	L220/L250	●	M24x65	8
171-156580	2	387x25x570	39	11156580	L220	○	M24x65	8
171-207279	2	460x30x640	58	17207279	L260	○	M24x65	8
171-111250	2	450x50x 816	118	11111250	L330/L350	○	1 1/4"x3-3/4 (95)	8

Bruxite™ Base and Bolt-on edges CAT



Item No.	Name	Quantity	Dimension mm	Kg/pc	Reference no.	Note	Stock	Bolt/no.
171-353601	Base edge		300x40x3033	259	7V1490	Countersunk	○	1 1/4"x3-1/4 (83)
171-462260	Bolt-on edge	2	360x30x1319	105	1U0593		●	
171-462270	Bolt-on edge	2	510x35x200	26	4T2435/3G6395		●	12 pc
171-465870	Bolt-on edge	2	406x35x1526	158	1U0593+3G6395		○	8 pc
171-354902	Base edge		300x40x3200	277	7I3015 planför	Countersunk	○	1 1/4"x3-1/4 (83)
171-465520	Bolt-on edge	2	360x30x1400	112	100-6668		●	
171-462270	Bolt-on edge	2	510x35x200	26	4T2435/3G6395		●	12 pc
171-465920	Bolt-on edge	2	406x35x1604	168	"100-6668+3G6395"		●	8 pc
171-354361	Base edge		300x50x3315	351	7V4188	Countersunk	○	1 1/4"x3-3/4 (95)
171-464960	Bolt-on edge	2	406x41x1406	173	1U0762		●	
171-462500	Bolt-on edge	2	556x40x265	43	1U0761		●	12 pc
171-473090	Bolt-on edge	2	406x41x1676	207	"1U0762+1U0761"		●	8 pc
171-358431	Base edge		300x50x3405	366	111-9770	Countersunk	○	1 1/4"x3-3/4 (95)
171-468170	Bolt-on edge	2	406x41x1448	177	109-9230		●	
171-468160	Bolt-on edge	2	556x45x265	48	100-4043		●	12 pc
171-490210	Bolt-on edge	2	406x35x1730	183	"109-9230+100-4043"		●	8 pc
171-358481	Base edge		300x40x3560	361	6W9311	Countersunk	○	1 1/4"x3-1/4 (83)
171-472460	Bolt-on edge	2	406x35x1524	161	9W1375		●	
171-462500	Bolt-on edge	2	556x40x265	43	1U0761		●	12 pc
171-358494	Bolt-on edge	2	406x41x1790	224	"9W1375+1U0761"		○	8 pc
171-358435	Base edge		300x50x3690	405		Countersunk	○	1 1/4"x3-3/4 (95)
171-498701	Bolt-on edge	2	406x41x1580	197	104-5841		●	
171-462500	Bolt-on edge	2	556x40x265	43	1U0761		●	12 pc
171-356121	Base edge		350x50x3772	468	4E8112	Countersunk	○	1 1/4"x3-3/4 (95)
171-469310	Bolt-on edge	1	500x40x1332	195	101-9350		●	
171-469300	Bolt-on edge	2	500x40x1242	183	102-2184		●	21 pc
930-1167460	Half arrow	7	457x73/46x312	41	116-7460	NWP	○	21 pc

Bruxite™ Spade nose and Bolt-on edges CAT



Item No.	Name	Quantity	Dimension mm	Kg/pc	Reference no.	Note	Stock	Bolt	No.
171-359641	Spade nose edge		3085/562x580/265x40	401	6W2993	Countersunk	○	1 1/4"x3-1/4 (83)	
171-476130	Bolt-on edge CTR	1	360x30x572	45	4T9185		○		
171-476110	Bolt-on edge LH End	1	360x30x637	50	4T9128		○		
171-476150	Bolt-on edge RH End	1	360x30x637	50	4T9127		○		
171-476120	Bolt-on edge LH CTR	1	360x30x655	52	4T9126		○		
171-476140	Bolt-on edge RH CTR	1	360x30x655	52	4T9125		○	18 pc	18
171-465950	Segment CTR	1	350x30x210	16	4T6697		○		
171-471030	Segment V	3	360x30x265	21	4T9124		○		
171-471040	Segment H	3	360x30x265	21	4T9123		○	14 pc	14
171-352710	Spade nose edge		3252/587x700/344x40	531	154-1604	Countersunk	○	1 1/4"x3-1/4 (83)	
171-498600	Bolt-on edge CTR	1	350x35x576	50	135-8240		○		
171-498602	Bolt-on edge LH End	1	350x35x603	52	135-8242		○		
171-498603	Bolt-on edge RH End	1	350x35x603	52	135-8243		○		
171-498601	Bolt-on edge LH CTR	1	350x35x784	69	135-8241		○		
171-498604	Bolt-on edge RH CTR	1	350x35x784	69	135-8244		○	18 pc	18
171-368940	Bolt-on edge CTR	1	406x41x576	70	"135-8240"		○		
171-368942	Bolt-on edge LH End	1	406x41x594	72	"135-8242"		○		
171-368943	Bolt-on edge RH End	1	406x41x594	72	"135-8243"		○		
171-368944	Bolt-on edge VM	1	406x41x785	96	"135-8241"		○		
171-368941	Bolt-on edge RH CTR	1	406x41x785	96	"135-8244"		○	18 pc	
171-357140	Spade nose edge		3492/650x645/265x50	632	134-1748	Countersunk	○	1 1/4"x3-3/4 (95)	
171-354761	Segment CTR	1	483x35x 312	38	4T7189/9W5734		●		
171-354760	Segment V	3	483x35x 312	40	4T7184/9W5730		○		
171-354762	Segment H	3	483x35x 312	40	4T7183/9W5737		○	21 pc	
930-1167460	Half arrow CTR	1	457x73/46x312	41	11-7460	NWP	●		
930-1167462	Half arrow V	3	457x73/46x312	42	116-7462	NWP	●		
930-1167461	Half arrow H	3	457x73/46x312	42	116-7461	NWP	●	21 pc	
171-357141	Spade nose edge		3492/650x700/320x50	678		Countersunk	○	1 1/4"x3-3/4 (95)	
171-479752	Bolt-on edge CTR	1	406x35x634	65	109-9123		●		
171-479750	Bolt-on edge LH End	1	406x35x654	67	109-9125		●		
171-479754	Bolt-on edge RH End	1	406x35x654	67	109-9121		●		
171-479751	Bolt-on edge LH CTR	1	406x35x819	84	109-9124		●		
171-479753	Bolt-on edge RH CTR	1	406x35x819	84	109-9122		●	21 pc	
171-354761	Segment CTR	1	483x35x 312	38	4T7189/9W5734		●		
171-354760	Segment V	3	483x35x 312	40	4T7184/9W5730		○		
171-354762	Segment H	3	483x35x 312	40	4T7183/9W5737		○	21 pc	
930-1167460	Half arrow CTR	1	457x73/46x312	41	11-7460	NWP	●		
930-1167462	Half arrow V	3	457x73/46x312	42	116-7462	NWP	●		
930-1167461	Half arrow H	3	457x73/46x312	42	116-7461	NWP	●	21 pc	
171-354750	Spade nose edge		3645/690x700/304x50	715	8R4649(9V3562)	Countersunk	○	1 1/4"x3-3/4 (95)	
171-370600	Bolt-on edge CTR	1	500x40x706	103	"9W5733"		●		
171-370580	Bolt-on edge LH End	1	500x40x731	107	"9W5732"		●		
171-370620	Bolt-on edge RH End	1	500x40x731	107	"9W5735"		●		
171-370590	Bolt-on edge LH CTR	1	500x40x791	115	"9W5731"		●		
171-370610	Bolt-on edge RH CTR	1	500x40x791	115	"9W5736"		●	27 pc	
171-354761	Segment CTR	1	483x35x312	38	"9W5734"		●		
171-354760	Segment V	3	483x35x312	40	"9W5730"		○		
171-354762	Segment H	3	483x35x312	40	"9W5737"		○	21 pc	
930-1167460	Half arrow CTR	1	457x73/46x312	41	116-7460	NWP	●		
930-1167462	Half arrow V	3	457x73/46x312	42	116-7462	NWP	●		
930-1167461	Half arrow H	3	457x73/46x312	42	116-7461	NWP	●	21 pc	
930-1957180	Top lock CTR	1	209x32x343	12	CAT 195-7180	NWP	○	1 1/4"x6-1/2 (165)	
930-1957182	Top lock V	3	209x32x406	12	CAT 195-7182	NWP	○		
930-1957181	Top lock H	3	209x32x406	12	CAT 195-7181	NWP	○	21 pc	

Bruxite™ Spade nose and Bolt-on edges CAT

Item No.	Name	Quantity	Dimension mm	Kg/pc	Reference no.	Note	Stock	Bolt	No.
171-354755	Spade nose edge		3962/1019x700/306x50	792	S034257	Countersunk	○	1 1/4"x3-3/4 (95)	
171-370600	Bolt-on edge MV	1	500x40x706	103	"9W5733"		●		
171-355801	Bolt-on edge MH	1	500x40x312	45	"9W5734"		○		
171-370580	Bolt-on edge LH End	1	500x40x731	107	"9W5732"		●		
171-370620	Bolt-on edge RH End	1	500x40x731	107	"9W5735"		●		
171-370590	Bolt-on edge LH CTR	1	500x40x791	115	"9W5731"		●		
171-370610	Bolt-on edge RH CTR	1	500x40x791	115	"9W5736"		●	28 pc	
171-370760	Spade nose edge		3980/664x705/359x60	943	"1566388"	Countersunk	○	1 1/4"x3-3/4 (95)	
930-1099080	Half arrow CTR	1	457x73/46x342	47	109-9080	NWP	○		
930-1099082	Half arrow V	3	457x73/46x342	44	109-9082	NWP	○		
930-1099081	Half arrow H	3	457x73/46x342	44	109-9081	NWP	○	21 pc	
930-1957180	Top lock CTR	1	209x32x343	12	CAT 195-7180	NWP	○	1 1/4"x6-1/2 (165)	
930-1957182	Top lock V	3	209x32x406	12	CAT 195-7182	NWP	○		
930-1957181	Top lock H	3	209x32x406	12	CAT 195-7181	NWP	○	21 pc	

Bruxite™ Base and Bolt-on edges Ljungby



Item No.	Name	Quantity	Dimension mm	Kg/pc	Reference no.	Note	Stock	Bolt	No.
171-355280	Base edge		200x30x2630	113	303186-01		○	M24x70	
171-464050	Bolt-on edge	1	250x30x982	53			●		
171-464060	Bolt-on edge	2	250x30x838	45			●	10 pc	
171-355170	Base edge		250x30x2803	154			○	M24x70	
171-464060	Bolt-on edge	1	250x30x838	45			●		
171-464050	Bolt-on edge	2	250x30x982	53			●	11 pc	
171-360370	Base edge		250x30x2970	163	303189-02		○	M24x70	
171-464050	Bolt-on edge	3	250x30x982	53			●	12 pc	
171-359200	Base edge		250x30x4190	230	0306616-01		○	M24x70	
171-464060	Bolt-on edge	5	250x30x838	45			●	15 pc	

Bruxite™ Base and Bolt-on edges Universal

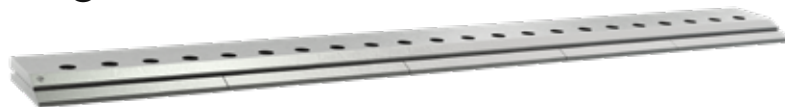

Item No.	Name	Dimension mm	Kg/pc	Note	Stock	Bolt	Holes
171-352630	Base edge	270x30x3000	172	Countersunk	●	M24x60	19
171-494840	Base edge	300x40x3500	299	Countersunk	●	M24x65	22
171-494980	Base edge	300x40x6050	513	Countersunk	○	M24x65	39
171-360192	Bolt-on edge	330x25x6050	364	c-c 129/152,4	●	M24/1"	39
171-360191	Bolt-on edge	360x30x6092	480	c-c 74/152,4	●	M24/1"	40
171-361010	Bolt-on edge	406x41x6092	751	c-c 74/152,4	●	M24/1"	40
171-451295	Bolt-on edge	360x40x759	79	c-c 74/152,4	●	M24/1"	5
171-451285	Bolt-on edge	360x40x608	63	c-c 74/152,4	●	M24/1"	4
171-451305	Bolt-on edge	360x40x683	71	c-c 74/152,4 end steel	●	M24/1"	4

Bruxite™ Base and Bolt-on edges Snow plows



Item No.	Name	Quantity	Dimension mm	Kg/pc	Note	Stock	Bolt	No.
171-359250	Base edge		200x20x2010	59	Siljum	○		
171-462390	Bolt-on edge	3	200x16x678	16		●	FH M20x60	9 pc
171-462391	Bolt-on edge serrated	3	200x16x678	13		○	FH M20x60	9 pc
171-857501	Base edge		150x20x2130	46	Drivex/UFO	○		
171-857492	Bolt-on edge	3	220x16x710	18		●	FH M16x55	9 pc
171-155450	Bolt-on edge serrated	3	220x16x710	15	4857492	○	FH M16x55	9 pc
171-857502	Base edge		200x20x2300	68	Drivex/Pome/Siljum	○		
171-857493	Bolt-on edge	3	220x16x768	20		●	FH M16x55	9 pc
171-156030	Bolt-on edge serrated	3	220x16x768	15	4857493	○	FH M16x55	9 pc
171-359900	Base edge		200x20x2500	74	4858527	○		
171-462350	Bolt-on edge	4	203x19x626	17		●	FH M20x60	12 pc
171-466001	Bolt-on edge serrated	4	203x19x626	14		●	FH M20x60	12 pc
171-359905	Base edge		200x20x2500	73	Siljum	○		
171-462350	Bolt-on edge	2	203x19x626	17		●		
171-462355	Bolt-on edge	2	203x19x663	19		●	FH M20x60	12 pc
122-496424	Sharq P300 HD	2	200x16x792	14		●		
122-496434	Sharq P300 HD	1	200x16x915	16		●	KH M16x55	9 pc
171-353250	Base edge		200x20x2600	76	Drivex/Siljum/UFO	●		
171-462350	Bolt-on edge	2	203x19x626	17		●		
171-462380	Bolt-on edge	2	203x19x686	20		●	FH M20x60	12 pc
171-466001	Bolt-on edge serrated	2	203x19x626	14		●		
171-465991	Bolt-on edge serrated	2	203x19x686	15		●	FH M20x60	12 pc
171-495075	Base edge		200x25x2600	94	Siljum	●		
171-462355	Bolt-on edge	2	203x19x663	19		●		
171-462380	Bolt-on edge	2	203x19x686	20		●	FH M20x60	12 pc
171-466005	Bolt-on edge serrated	2	203x19x663	15		●		
171-465991	Bolt-on edge serrated	2	203x19x686	15		●	FH M20x60	12 pc
122-496424	Sharq P300 HD	1	200x16x792	14		●		
122-496434	Sharq P300 HD	2	200x146x915	16		●	KH M16x55	9 pc
171-359240	Base edge		2030x20x2750	80	Drivex/UFO	●		
171-462380	Bolt-on edge	4	203x19x686	20		●	FH M20x60	12 pc
171-465991	Bolt-on edge serrated	4	203x19x686	15		●	FH M20x60	12 pc
171-495070	Base edge		200x25x2760	100	Siljum	●		
171-462380	Bolt-on edge	2	203x19x686	20		●		
171-462385	Bolt-on edge	2	203x19x721	20		●	FH M20x60	12 pc
171-465991	Bolt-on edge serrated	2	203x19x686	15		●		
171-465995	Bolt-on edge serrated	2	203x19x721	16		●	FH M20x60	12 pc
122-496434	Sharq P300 HD	3	200x16x915	16		●	KH M16x55	9 pc
171-354910	Base edge		200x25x2951	107	Siljum	○		
171-465820	Bolt-on edge	4	254x19x734	27		●	FH M24x65	12 pc
171-465821	Bolt-on edge serrated	4	254x19x734	22		●	FH M24x65	12 pc
171-859041	Base edge		200x25x3000	108	Drivex/UFO	●		
171-859042	Bolt-on edge	5	250x25x608	27		●	FH M24x65	15 pc
171-859042X	Bolt-on edge	5	330x25x608	42		●	FH M24x65	15 pc
171-466721	Bolt-on edge serrated	5	330x25x608	31		●	FH M24x65	15 pc
171-495050	Base edge		200x25x3050	111	Siljum	●		
171-857494	Bolt-on edge	3	254x19x608	22		●		
171-450861	Bolt-on edge	2	254x19x660	23		●	FH M20x60	15 pc
171-154510	Bolt-on edge serrated	3	254x19x608	16		●		
171-154515	Bolt-on edge serrated	2	254x19x660	18		●	FH M20x60	15 pc
122-496434	Sharq P300 HD	2	200x16x915	16		●		
122-496444	Sharq P300 HD	1	200x16x1220	21		●	KH M16x55	10 pc
171-353220	Base edge		200x25x3200	116	Siljum	○		
171-462220	Bolt-on edge	4	254x19x818	30		●	FH M24x65	12 pc
171-462221	Bolt-on edge serrated	4	254x19x818	28		○	FH M24x65	12 pc

● Stock ○ Order item

Bruxite™ Base and Bolt-on edges Snow plows Universal



Item No.	Name	Quantity	Dimension mm	Kg/pc	Note	Stock	Bolt	No.
171-483860	Base edge		200x20x2440	72	Universal	○		
171-495010	Bolt-on edge	2	203x19x1217	35		○	FH M16x55	8 pc
122-459470	Serrated ice edge	2	203x16x1220	21		●	FH M16x55	8 pc
122-496444	Sharq P300 HD	2	200x16x1220	21		●	KH M16x55	8 pc
171-358273	Base edge		200x25x2745	100	Universal	○		
171-494950	Bolt-on edge	3	203x19x914	26		●	FH M16x55	9 pc
122-459460	Serrated ice edge	3	203x16x915	16		●	FH M16x55	9 pc
122-496434	Sharq P300 HD	3	200x16x915	16		●	KH M16x55	9 pc
171-358280	Base edge		200x25x3050	111	Universal	○		
171-494950	Bolt-on edge	2	203x19x914	26		●		
171-495010	Bolt-on edge	1	203x19x1217	35		○	FH M16x55	10 pc
122-459480	Serrated ice edge	2	203x16x1525	26		●	FH M16x55	10 pc
122-496454	Sharq P300 HD	2	200x16x1525	26		●	KH M16x55	10 pc
171-494931	Base edge		200x20x2600	77	Universal	○		
171-494940	Bolt-on edge	1	203x19x792	23		●		
171-494950	Bolt-on edge	2	203x19x914	26		●	FH M16x55	9 pc
122-459450	Serrated ice edge	1	203x16x792	14		●		
122-459460	Serrated ice edge	2	203x16x915	16		●	FH M16x55	9 pc
122-496424	Sharq P300 HD	1	200x16x792	14		●		
122-496434	Sharq P300 HD	2	200x16x915	16		●	KH M16x55	9 pc

Bolts and nuts



FH KH



Trilock nut Flange nut with plastic locking

Bolt

Item No.	Dimension	Note	Kg/pc
959-590430	M16x55	Quality 12.9	0,10
959-590310	M16x65	Quality 12.9	0,11
959-590726	M20x60	Quality 10.9	0,15
959-590730	M20x65	Quality 10.9	0,17
959-590710	M20x70	Quality 10.9	0,18
959-590750	M24x65	Quality 10.9	0,25
959-142571	M24x70	Quality 10.9	0,20
959-590740	M24x80	Quality 10.9	0,30
959-590520	1"x83		0,35
959-590850	1 1/4"x3-1/4 (83)		0,72
959-590690	1 1/4"x3-3/4 (95)	8T9079 fully threaded	0,72
959-590470	1 1/4"x4-1/8 (104)	5P8823	0,77
959-590473	1 1/4"x6-1/2 (165)		1,07

Nut

Item No.	Dimension	Note	Kg/pc
959-590360	M16	Trilock	0,04
959-590350	M16	Flange locking nut	0,05
959-590660	M20		0,06
959-590670	M20	Trilock	0,06
959-510093	M20	Flange nut	0,09
959-948836	M24	Trilock	0,09
959-590680	M24		0,09
959-590390	1"		0,12
959-590480	1 1/4"		0,24
959-590485	1 1/4"	Nut	0,22

Screw length guide

Thickness base edge		Screw length	Thickness recessed base edge		Screw length
M16	20	55	M20	30	60
	25	60		35	60
M20	25	60	M24	40	65
	30	65		50	80
	35	70		1 1/4"	40
M24	25	65		50	95
	30	70		65	95
	35	80			
	40	80			
1 1/4"	65	104			

Bucket teeth type CAT J

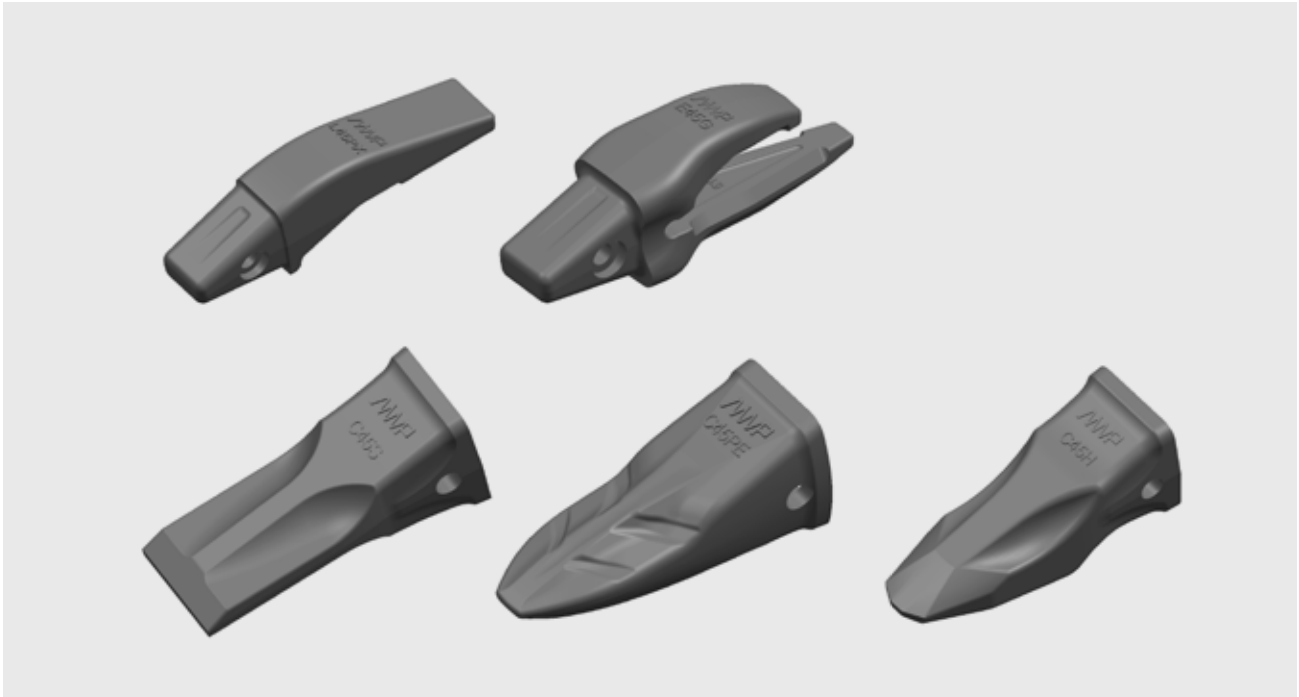

Item No.	Name		Weight kg
J200 For steel thickness 16 - 20			
930-484200	Tip penetration	C20S	1,3
930-484201	Pin	Ø11X55	0,04
930-484202	Washer	Ø11/19	0,02
930-484203	Adapter excavator	E20G	1,5
J250 For steel thickness 25 mm			
930-484210	Tip penetration	C25S	3,1
930-484211	Pin	Ø14X77	0,09
930-484223	Washer	Ø14/27	0,03
930-484213	Adapter excavator	E25G	4,1
930-484214	Adapter loader	L25P	5,5
J300 For steel thickness 30 mm			
930-484220	Tip penetration	C30S	5,5
930-484221	Tip abraison	C30PE	5,8
930-484222	Pin	Ø14X92	0,11
930-484223	Washer	Ø14/27	0,03
930-484224	Adapter excavator	E30G	7,1
930-484225	Adapter loader	L30P	8
J350 For steel thickness 40 mm			
930-484230	Tip penetration	C35S	7,6
930-484231	Tip abraison	C35PE	8,1
930-484232	Tip loader	C35A	11
930-484233	Pin	Ø19X102	0,24
930-484234	Washer	Ø19/36	0,06
930-484235	Adapter excavator	E35G	9,6
930-484236	Adapter loader	L35P	13,2

Item No.	Name		Weight kg
J450 For steel thickness 50 mm			
930-484271	Tip penetration	C45S	13,5
930-484270	Tip abraison	C45PE	14,6
930-484272	Tip loader	C45A	21,2
930-484274	Pin	Ø24x133	0,46
930-484275	Washer	Ø24/41	0,06
930-484276	Adapter excavator	E45GX	19,3
930-484277	Adapter loader	L45PX	20,0
930-472860	Two-strap adapter loader	L45GM	21,8
930-472870	Two-strap adapter loader	L45GV	21,8
930-472880	Two-strap adapter loader	L45GH	21,8
J550 For steel thickness 60 mm			
930-484281	Tip abraison	C55PE	22,2
930-484282	Tip loader	C55A	29,7
930-484283	Pin	Ø25X160	0,63
930-484284	Washer	Ø25/48	0,10
930-484285	Adapter excavator	E55G	33,0
930-484287	Two-strap adapter loader	L55GM	42,9
J600 For steel thickness 70 mm			
930-484290	Tip abraison	C60PE	37,6
930-484291	Pin	Ø30X191	1,10
930-484292	Washer	Ø30/51	0,10
930-484293	Adapter excavator	E60G	54,5

Bruxite™ Edge protectors

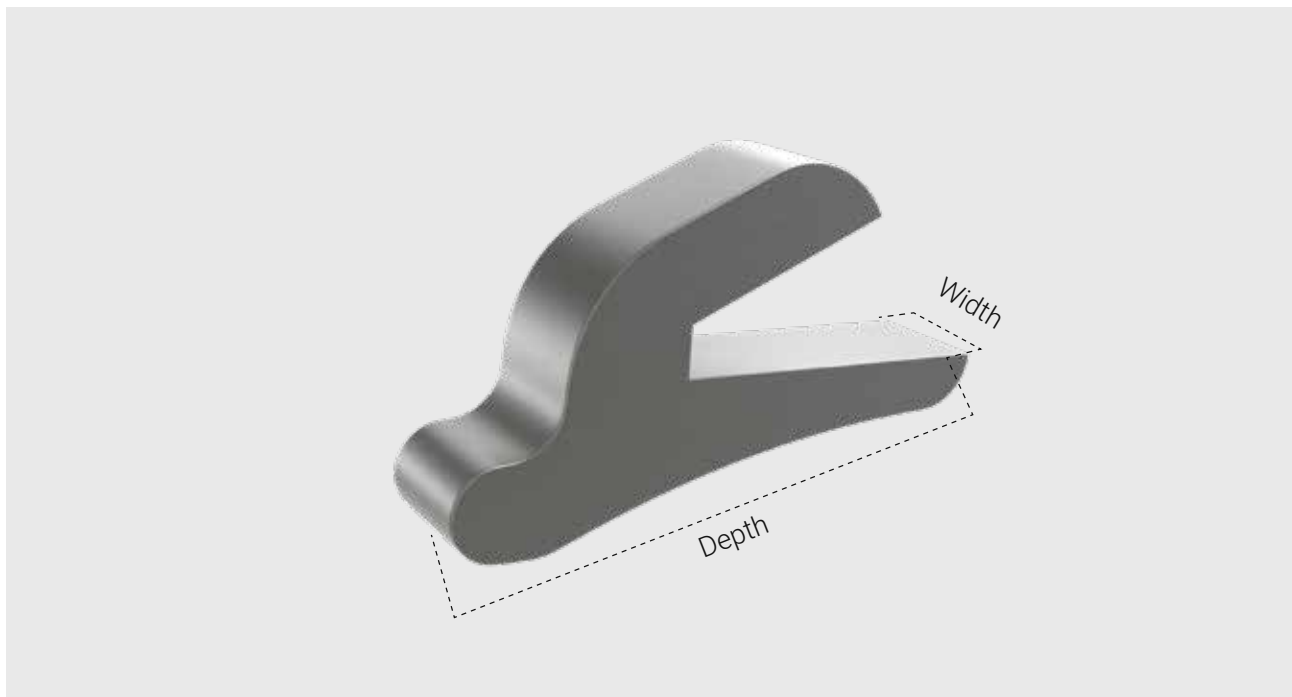

Edge protectors – for welding

Item No.	For cutting thickness mm	Depth mm	Width mm	Weight kg
171-472965	50 mm	220	60	5,2
171-472966	60 mm	245	60	7,0
171-472967	70 mm	290	65	10,2

Excagrip™ excavator spike



- + Grip on all surfaces
- + Increased security
- + Removable and easy to assemble

Excagrip™ excavator spike

Excagrip gives tracked excavators incredible grip on ice, rock and slopes. The system is made up of a through-hardened adapter, welded into the track plates between the ridges, and removable carbide stingers.

The carbide stingers are hammered into place and they can be easily removed with the demounting tool.

Item No.	Name	Kg/pc
135-357330	Holder for excavator spike ø 19 mm	0,28
920-154010	Carbide spike 19 mm	0,31
135-357335	Holder for excavator spike ø 22 mm	0,25
920-153981	Carbide spike 22 mm	0,30

Welding instructions Bruxite™

Bruxite™

Areas of use

Bruxite™ wear and cutting steels are intended for applications where high wear resistance is required.

Material properties

Bruxite™ is a hardened boron steel according to EN 10083-3. The chemical properties of this material, together with the manufacturing method, ensures good wear properties as well as excellent properties during welding (preheating min. 50 °C). NOTE: Avoid welding in areas that are exposed to fatigue loads unless the steel has been specially treated in advance.

Mechanical properties These values are intended as guidelines for materials 15 to 50 mm thick.	Stretch limit Rp0.2 N/mm ²	Break resistance Rm N/mm ²	Extension As in %	Impact strength	
	t °C	KV J			
	1200	1600	6	- 40	20
Hardness	Material thickness t ≤ 30 mm 500 +/- 25 HB, t ≥ 35 mm 500 +/- 40 HB				

Bruxite™, working temperature for different material thicknesses

In the table below you can read what temperature the material should be preheated to before welding. At the same time, it is the temperature the material should have between the strands in a multi-strand joint. Drawn example: 30 mm. wall thickness.

- Butt weld: 180 °C
- Fillet weld: 120 °C

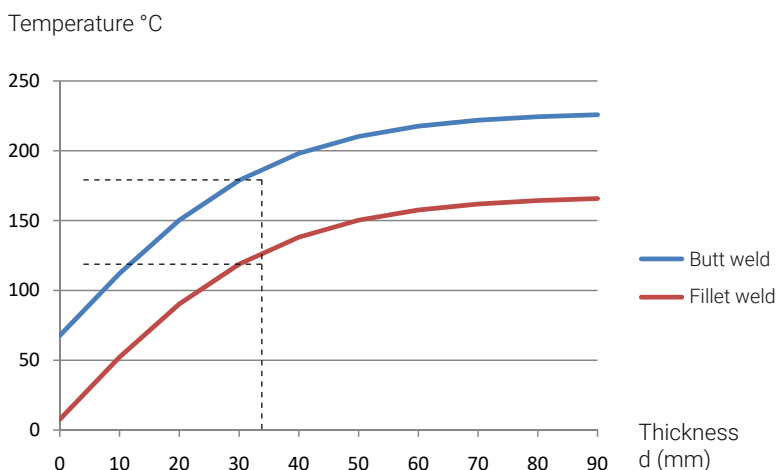

The values of the table are calculated according to standard EN1011 method B.

- Weldability value CET = 0.43 applies to all Bruxite™.
- Heat supply Q = 1.2 kJ / mm. corresponds to normal manual welding, both MAG and MMA.
- Mechanical welding with significantly higher heat supply should be calculated separately.

Guidelines for welding

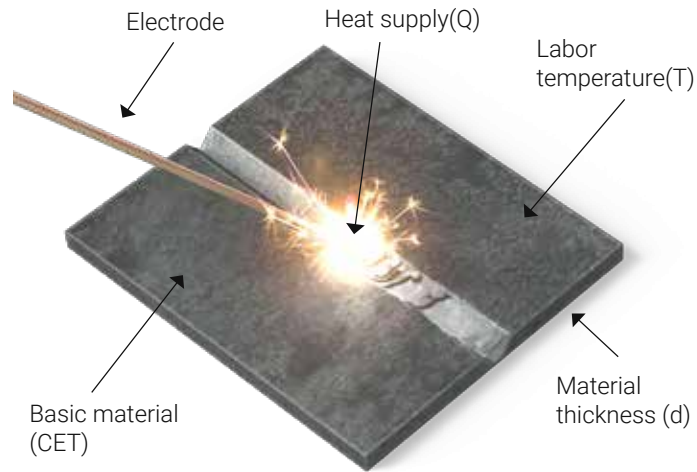

- ▶ Make sure that the material has suitable joints and that the gap is not wider than 3 mm.
- ▶ Make sure that the surfaces to be welded are clean and dry.
- ▶ Plan the different steps of the welding work and select electrodes before welding. (Disposable or repeated welding)
- ▶ Preheat the material according to the recommended welding instructions. When welding in an environment with high humidity, special measures must be taken.
- ▶ The working temperature should not exceed 225 ° C because the material then start to anneal, which leads to deteriorating material properties.
- ▶ The working temperature must be measured 75 mm from the center of the weld.
- ▶ We recommend that you use temperature-marking crayons to be able to control the temperature.
- ▶ The electrodes should be stored according to the manufacturer's recommendations to prevent them from absorbing moisture. Any preheating must be done before puncturing the material.

Recommended materials for Bruxite™

Electrode for manual welding (welding pin, MMA).

OK 48.30, OK 48.00 (E7018), OK 74.78 (E9018-D1) or equivalent.

MAG welding (Gas metal arc welding)

OK Autorod 12.51, OK Autorod 12.50 (ER70S-6),

OK Autorod 13.13, OK Tuberod 14.13 (E70C-6M).

Argon gas with 16% CO₂ or 23% CO₂ is recommended as shielding gas.

Tolerances

Controls / Samples

Olofsfors has a test lab with advanced measuring equipment, where we analyze the chemical constituents of the materials. Through this, we can ensure that we get an end product with the right properties, in terms of hardness and durability.

Vickers test

For more thorough examination, hardness tests are performed according to ISO 6507-1 with a four-sided 136 ° diamond pyramid tip whose pressing force is adapted to the current hardness range. Sample preparation of the substance is done by grinding in several steps to achieve acceptable surface smoothness, and the substance must not be heated to decomposition. HV10 is usually selected for hardened steel = 10 Kilos of compressive force in a calibrated Vicker tester. The impression is read under a microscope and calculated the mean value of the size in both joints gives the highest accuracy of all methods of determining hardness of material.

Tolerances

The tolerances of the product are in accordance with ISO 2768 unless the circumstances require special tolerances. In general, the contours of the product are according to ISO 2768 v, the c / c of the holes according to ISO 2768 m. In general, max. 1.7 mm / m deviation for the straightness of the edges. The tolerances of the raw materials are according to EN 10029, EN 10060, EN 10058, and EN 10092-1.

Surface quality

The tolerances on the surface finish are according to EN 10163, unless otherwise specified in the order.

